

*Technical Report of Universal Mechanical Splice*  
*--- FMSEZ-025/09 ---*

This technical report demonstrates the reliability performance of the FMSEZ-025/09, "Universal Mechanical Splice". The report is provided for Fujikura's sales partners, distributors, or agents to better understand the product and smoothly promote them.

All technical data are deemed reliable, but not guaranteed. These data are meant to provide clients better understanding of the products' overall performance.

If you have any questions, feel free to contact Fujikura.

**Contact to:**

**Yutaka Kurosawa**  
**Manager**  
**Fiber Optics Network Products Engineering Department**  
**Fiber Optics Components & System Division**

**Fujikura Ltd.**

**Mail: [kurosawa@fujikura.co.jp](mailto:kurosawa@fujikura.co.jp)**

**Address: 1-5-1 Kiba Koto-ku Tokyo, 135-8512 Japan**  
**Tel: +81-3-5606-1203**  
**Fax: +81-3-5606-1536**

## Technical Report of Universal Mechanical Splice --- FMSEZ-025/09 ---

### Features

The FMSEZ-025/09 has its own mechanism of "Push-pull-wedge". Unlike 3M's Mechanical Splice, the "Push-pull-wedge" mechanism achieves clamping both bare fiber part and coating part simultaneously. And then this clamping mechanism enhances strength against fiber twist.

Fiber holders ensure proper cleaving length and good fiber contact.

The FMSEZ-025/09 is applied for 250um-coated fibers or 900um-coated fibers, and used for either single-mode or multi-mode fibers.

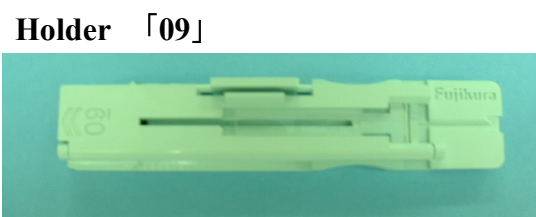
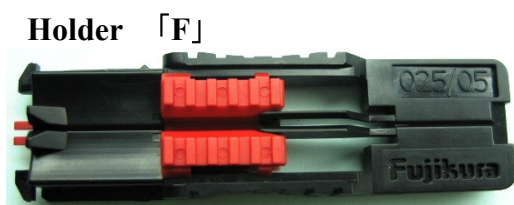
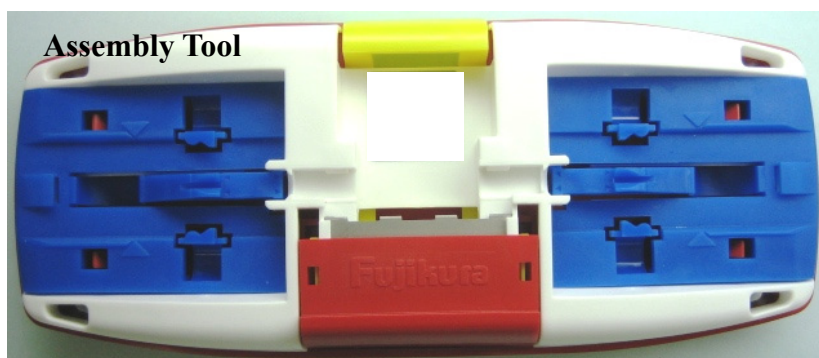

Fujikura proprietary

## 1. Description

### 1.1. Applications

- 125um single fiber 250um coated, or 900um coated fiber
- Either single-mode or multi-mode fibers
- Applicable combination for mechanical splicing of coated fibers
  - 900um to 900um
  - 900um to 250um
  - 250um to 250um

### 1.2 Structure

Both bare fiber part and coating part are clamped simultaneously as below figure.

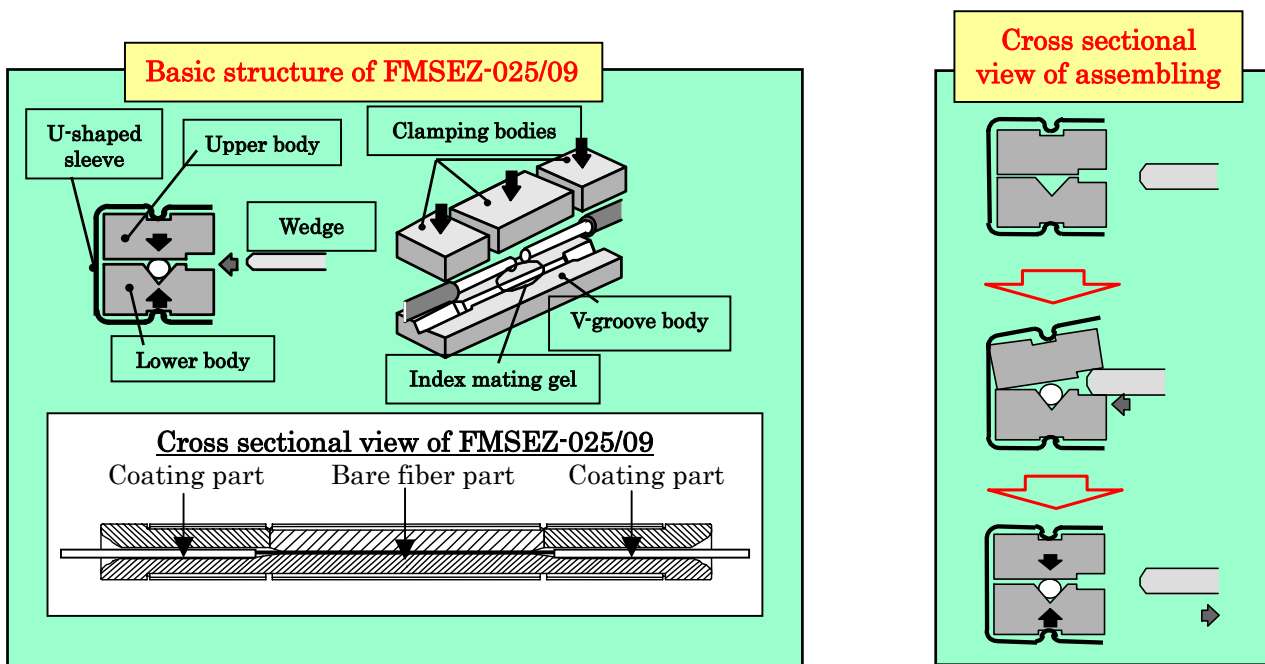

### 1.3. Dimensions

FMSEZ-025/09 ; L 40 \* W4 \* H 4 (mm)

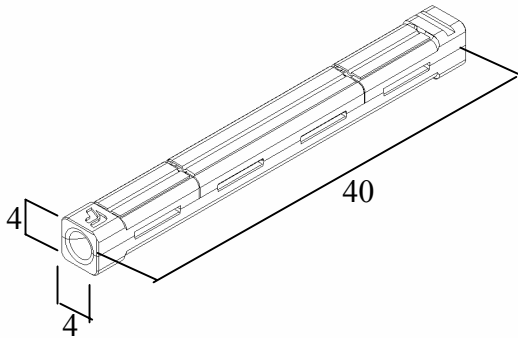

Assembly tool ; L 138 \* W73 \* H 45 (mm)

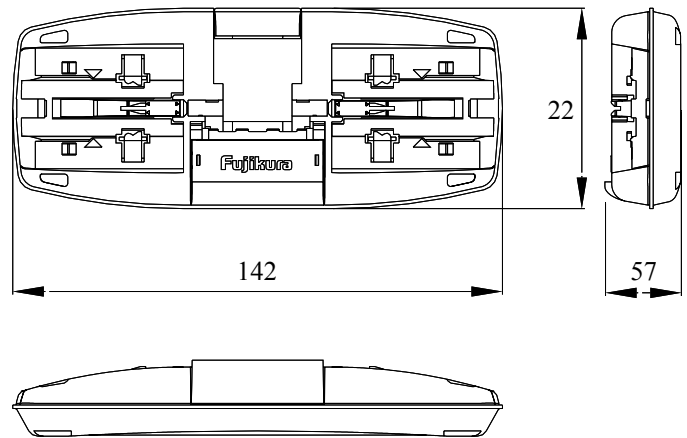

Holder 「F」

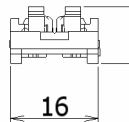
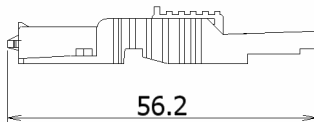
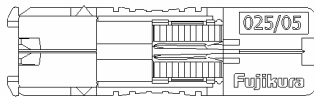

Holder 「09」

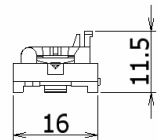
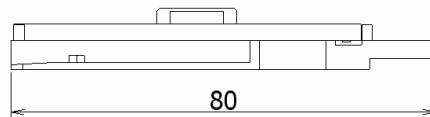
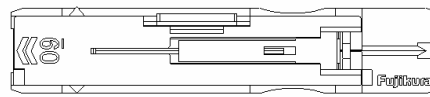

### 1.4. Applicable temperature range of 900um coated fibers

900um Fiber Coating	Applicable Temperature Range
PVC	-40°C to 75°C
Nylon	0°C to 75°C
TPEE	-25°C to 75°C

### 3. Test Descriptions and Procedures

- Tests are categorized into 3 series, namely,
  1. **As-Received, Storage, Handling**
  2. **Installation and Assembly Conditions**
  3. **Environmental Life Testing**
- Test conditions and criteria are determined with reference to **Telcordia GR-765-CORE Generic Requirements for Single Fiber Single-Mode Optical Splices and Splicing Systems**,
- All the tests were carried out with “heterogeneous” optical fibers (different lots of same type fibers),
- Measurement values in all the tests indicate actual insertion and return losses,
- Fibers in all the tests were cleaved with Fujikura CT-30,
- Thirty (30) connectors were constructed for product performance, and ten (10) connectors were constructed for mechanical/environmental performance,
- Insertion losses were measured as below.

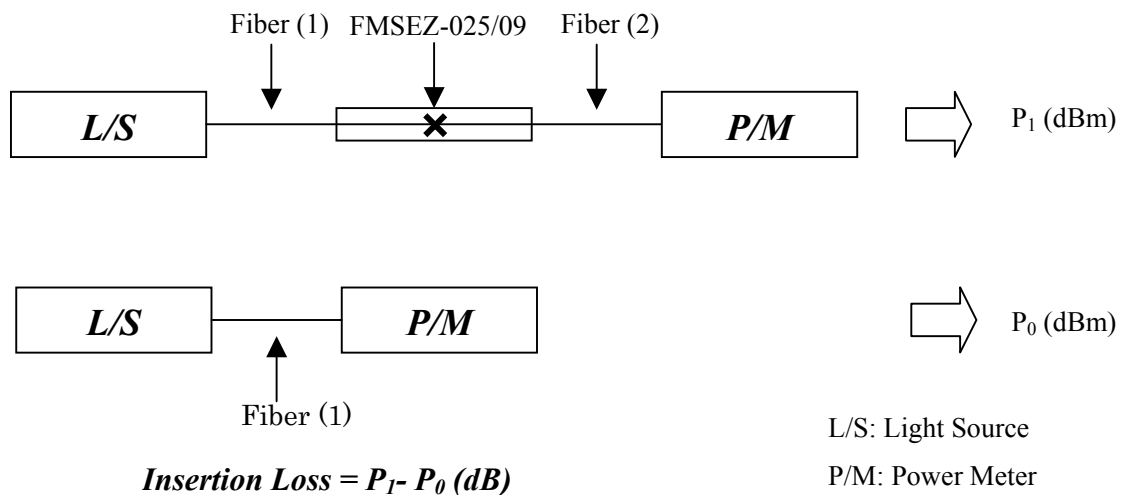

### **3. As-Received, Storage, Handling**

This series of tests is designed to analyze the assembly tool performance on an “as received” basis and then subject the equipment to a sequential series of handling, transportation and storage tests.

#### **3.1. Test Conditions**

##### **3.1.1. Initial Operation**

- Splices were assembled at room temperature conditions, 22°C, <60% relative humidity
- Loss and reflectance were recorded.

##### **3.1.2. Shock – Corners & Edges**

- Tool was lifted 7.3cm, 10° with the horizontal.
- Subjected to drop on each edge and corner opposite to the rest surface.
- Test surface of concrete covered with 0.3cm of asphalt tile.
- Splices were then assembled with the tool and loss and reflectance were recorded.

##### **3.1.3. Shock – Bottom**

- Tool was held at 76cm parallel to the horizontal.
- Subjected to impact on concrete covered with 0.3cm of asphalt tile.
- Splices were then assembled with the tool and loss and reflectance were recorded.

##### **3.1.4. Vibration, Transportation**

- 1.5g peak from 10 to 500Hz at a sweep rate 0.1octave/min in each of three positions along the three principle axes.
- Splices were then assembled with the tool and loss and reflectance were recorded.

##### **3.1.5. Storage, High Temperature**

- Tool was placed in an environmental chamber at 60°C with a 90% relative humidity and stored for 24hours.
- Allowed to stabilize for 60minutes at 23°C.
- Splices were then assembled with the tool and loss and reflectance were recorded.

##### **3.1.6. Storage, Low Temperature**

- Tool was placed in an environmental chamber at -40°C with an uncontrolled relative humidity and stored for 24hours.
- Allowed to stabilize for 60minutes at 23°C.
- Splices were then assembled with the tool and loss and reflectance were recorded.

### 3.2. Summary of Results

No.	Tests	Wavelength (nm)	900 $\mu$ m to 900 $\mu$ m		900 $\mu$ m to 250 $\mu$ m		250 $\mu$ m to 250 $\mu$ m	
			Mean Loss	Minimum Reflectance	Mean Loss	Minimum Reflectance	Mean Loss	Minimum Reflectance
3.2.1.	Initial Operation Splicing	1310 1550	Less than 0.15dB	More than 40dB	Less than 0.15dB	More than 40dB	Less than 0.15dB	More than 40dB
3.2.2.	Shock - Corners & Edges	1310 1550	Less than 0.15dB	More than 40dB	Less than 0.15dB	More than 40dB	Less than 0.15dB	More than 40dB
3.2.3.	Shock - Bottom	1310 1550	Less than 0.15dB	More than 40dB	Less than 0.15dB	More than 40dB	Less than 0.15dB	More than 40dB
3.2.4.	Vibration	1310 1550	Less than 0.15dB	More than 40dB	Less than 0.15dB	More than 40dB	Less than 0.15dB	More than 40dB
3.2.5.	Storage, High Temperature	1310 1550	Less than 0.15dB	More than 40dB	Less than 0.15dB	More than 40dB	Less than 0.15dB	More than 40dB
3.2.6.	Storage, Low Temperature	1310 1550	Less than 0.15dB	More than 40dB	Less than 0.15dB	More than 40dB	Less than 0.15dB	More than 40dB

Note: 900mm fibers used in the above tests are PVC coated tight-buffered fibers.

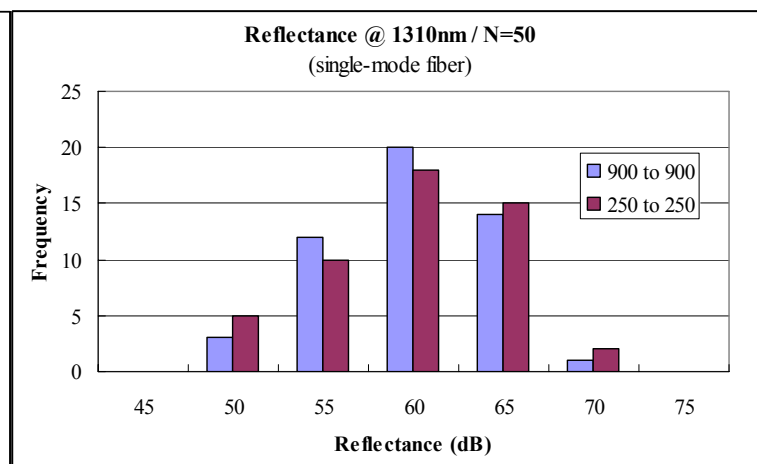
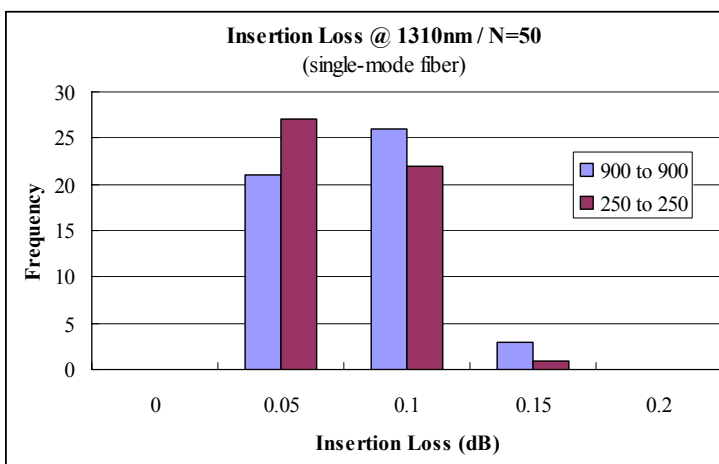

#### 4. Installation and Assembly Conditions

This series of tests is intended to analyze the actual operation of assembling or producing splices under a variety of installation conditions.

##### 4.1. Test Conditions

##### 4.1.1. Low Temperature

- Splices were assembled at 0°C with an uncontrolled humidity.

##### 4.1.2. High Temperature & Humidity

- Splices were assembled at 38°C with a relative humidity of 90%.

##### 4.1.3. High Temperature & Low Humidity

- Splices were assembled at 45°C with a relative humidity of 15%.

##### 4.2. Summary of Results

No.	Tests	Wavelength (nm)	900µm to 900µm		900µm to 250µm		250µm to 250µm	
			Mean Loss	Minimum Reflectance	Mean Loss	Minimum Reflectance	Mean Loss	Minimum Reflectance
4.2.1.	Low Temperature	1310	Less than 0.15dB	More than 40dB	Less than 0.15dB	More than 40dB	Less than 0.15dB	More than 40dB
		1550						
4.2.2.	High Temperature & High Humidity	1310	Less than 0.15dB	More than 40dB	Less than 0.15dB	More than 40dB	Less than 0.15dB	More than 40dB
		1550						
4.2.3.	High Temperature & Low Humidity	1310	Less than 0.15dB	More than 40dB	Less than 0.15dB	More than 40dB	Less than 0.15dB	More than 40dB
		1550						

Note: 900µm fibers used in the above tests are PVC coated tight-buffered fibers.



## **5. Environmental Life Testing**

This series of tests is designed to analyze the performance of the actual splices under conditions involving temperature cycling, high humidity, condensation, tensile load and vibration.

### **5.1. Test Conditions**

#### **5.1.1. Splice Strength**

- Splices were subjected to a tensile load of 4.4N for 1second.
- Loss and reflectance were recorded after the application of load.

#### **5.1.2. Temperature Cycling**

- -40°C to 75°C for 50 cycles.
- Loss and reflectance were monitored and recorded every 10 minutes during the test.

#### **5.1.3. Humidity / Condensation Cycling**

- -10°C to 65°C for 15 cycles.
- Loss and reflectance were monitored and recorded every 10 minutes during the test.

#### **5.1.4. Water Immersion**

- Splices were immersed in distilled water at 43°C for 7 days.
- Loss and reflectance were recorded before and 1 day after the test.

#### **5.1.5. Splice Vibration**

- Splices were subjected to simple harmonic motion having amplitude of 0.76mm, with frequency traversing from 10 to 55 Hz and return to 10 Hz in 1 minute.
- 2 hours in each of three mutually perpendicular planes.
- Loss and reflectance were recorded before and after the test.

#### **5.1.6. Temperature Cycling**

- -40°C to 75°C for 50 cycles.
- Loss and reflectance were monitored and recorded every 10 minutes during the test.

#### **5.1.7. Environmental Degradation**

- Splices were subjected to a tensile load of 4.4N for 1second.
- Loss and reflectance were recorded after the application of load.

## 5.2. Summary of Results

No.	Tests	Wavelength (nm)	900μm to 900μm		900μm to 250μm		250μm to 250μm	
			Maximum Change in Loss	Minimum Reflectance	Mean Loss	Minimum Reflectance	Mean Loss	Minimum Reflectance
5.2.1.	Splice Strength (Cable Retention)	1310	No increase in loss	More than 40dB	No increase in loss	More than 40dB	No increase in loss	More than 40dB
		1550						
5.2.2.	Temperature Cycling	1310	Less than 0.05dB	More than 40dB	Less than 0.05dB	More than 40dB	Less than 0.05dB	More than 40dB
		1550						
5.2.3.	Humidity/Condensation Cycling	1310	Less than 0.05dB	More than 40dB	Less than 0.05dB	More than 40dB	Less than 0.05dB	More than 40dB
		1550						
5.2.4.	Fluid Immersion (water)	1310	Less than 0.05dB	More than 40dB	Less than 0.05dB	More than 40dB	Less than 0.05dB	More than 40dB
		1550						
5.2.5.	Splice Vibration	1310	No increase in loss	More than 40dB	No increase in loss	More than 40dB	No increase in loss	More than 40dB
		1550						
5.2.6.	Post Condensation Temperature Cycling	1310	Less than 0.05dB	More than 40dB	Less than 0.05dB	More than 40dB	Less than 0.05dB	More than 40dB
		1550						
5.2.7.	Environmental Degradation	1310	No increase in loss	More than 40dB	No increase in loss	More than 40dB	No increase in loss	More than 40dB
		1550						

Note 1: 900μm fibers used in the above tests are PVC coated tight-buffered fibers.

Note 2: The temperature range for temperature cycling differs with different 900μm fibers. Refer to table below for the applicable temperature range.

900μm Fiber Coating	Applicable Temperature Range
PVC	-40°C to 75°C
Nylon	0°C to 75°C
TPEE	-25°C to 75°C

**Temperature Cycling Test  
(250 $\mu$ m SMF)**

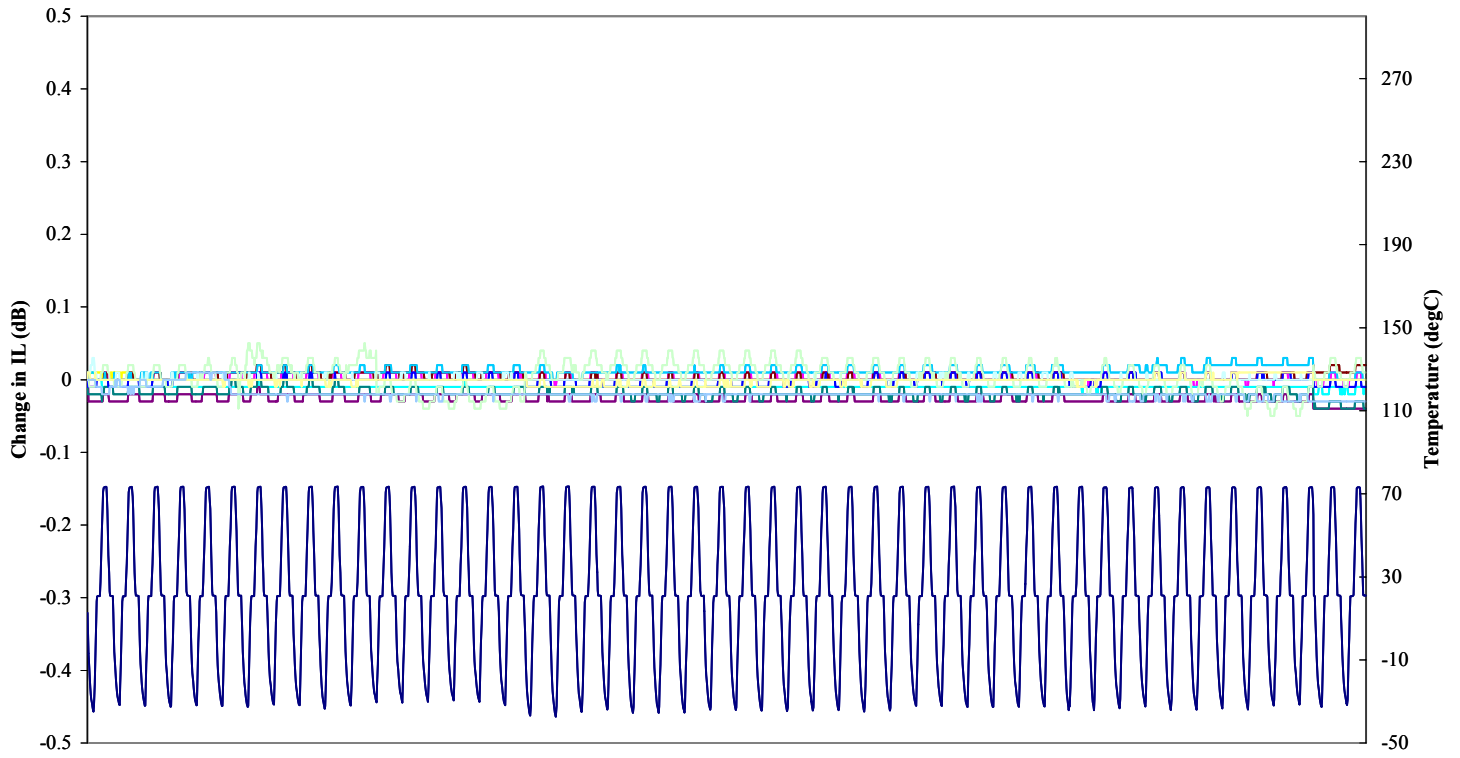

+++++ End of Technical Report +++++