



50 YEARS | 1970-2020
contacta



Window Intercom Systems

Enhance your customer service by aiding and improving your communication with customers



tele cron

telecroatian network
www.telecron.hr

Contents

	Section	Page
	Window Intercom Systems	
	Introduction	3
	Dual Speaker Pod System	6
	Speaker and Microphone Pod System	7
	Screen Mounted Microphone System	8
	Bridge Bar System	9
	Surface Mounted System	10
	Flush Mounted System	11
	Curved Microphone System	12
	Slimline Bridge Bar System	13
	Dual Overhead Speaker System	14
	Surface Mounted Entry System	15
	Components	16

Is communication easy for your customers?

If easy communication can't take place, the **effects on your business could be severe.**

Why should you improve your customer contact paths?

Conversations through safety screens at banks, post offices and other customer facing businesses are not effective without a system to aid them.

With the help of open duplex technology, speech can be transferred effectively through obstacles such as glazed partitions, meaning your customers and staff are guaranteed the best communication experience.

How does technology transform interaction in your organisation?

The components of a **quality window intercom system** include an amplifier designed for optimum performance, high-quality speakers and well-positioned microphones, so that your customers and staff can **converse both freely and flawlessly**.



Find out the benefits of our window intercom systems

- Unique multi-positional **noise cancelling microphone** for staff
- Range of options available to meet your needs for performance, positioning and image
- **Full open duplex operation** means no clipping of speech or manual control of speech path
- **Self-testing**, ensuring the system **stays fully functioning**
- High performance system with simple adjustable amplifier
- A hearing loop is provided as standard to perfect the listening experience for everyone
- **Unobtrusive** and **easy to install**
- Staff can be **heard clearly**
- More **engaging experience** for customers
- Transactions made simple and enjoyable



Dual Speaker Pod System

This entry level window intercom system provides high quality sound across partitions and safety screens, featuring dual speaker pods which can be either free standing or surface mounted. Our open duplex amplifier and mouse microphone are included.

It is an affordable system suitable for environments with low ambient noise.

Applications:

For use where one to one communication takes place through a safety screen:

- Nursing/Care Homes
- Hospitals/Health Clinics/Surgeries
- Reception Counters
- Banks
- Retail Stores

What's Included:

- Window Intercom Amplifier (see page 16)
- Mouse Microphone x2 (see page 28)
- Speaker Pod x2 (see page 17)
- PS-55 Power Supply (see page 29)

Optional Extras:

- Counter Hearing Loop Aerial (see page 24)
- Larger base available upon request

Physical Data:

Dimensions (boxed)	Height – 310mm (12.2") Width – 310mm (12.2") Depth – 160mm (6.2")
Construction	ABS Plastic
Finish	Black RAL 9005

Product Codes:

Dual Speaker Pod System	STS-K070
-------------------------	----------



Speaker and Microphone Pod System

This entry level window intercom system provides high quality sound across partitions and safety screens, featuring speaker and microphone pods which can be either free standing or surface mounted. Our open duplex amplifier and mouse microphone are included.

It is an affordable system suitable for environments with low ambient noise.

Applications:

For use where one to one communication takes place through a safety screen:

- Nursing/Care Homes
- Hospitals/Health Clinics/Surgeries
- Reception Counters
- Banks
- Retail Stores

What's Included:

- Window Intercom Amplifier (see page 16)
- Mouse Microphone (see page 28)
- Staff Loudspeaker Pod (see page 17)
- Speaker Pod (see page 17)
- PS-55 Power Supply (see page 29)

Optional Extras:

- Counter Hearing Loop Aerial (see page 24)
- Larger base available upon request

Physical Data:

Dimensions (boxed)	Height – 310mm (12.2") Width – 310mm (12.2") Depth – 160mm (6.2")
Construction	ABS Plastic
Finish	Black RAL 9005

Product Codes:

Speaker and Microphone Pod System	STS-K071
-----------------------------------	----------



Speaker Pod and Screen Mounted Microphone System

This entry level window intercom system provides high quality sound across partitions and safety screens. It features staff-side speaker and microphone pods which can be either free standing or surface mounted. Our open duplex amplifier and customer-side glass mounted microphone are included.

It is an affordable system suitable for a wide variety of environments.

Applications:

For use where one to one communication takes place through a safety screen:

- Nursing/Care Homes
- Hospitals/Health Clinics/Surgeries
- Reception Counters
- Banks
- Retail Stores

What's Included:

- Window Intercom Amplifier (see page 16)
- Screen Mounted Microphone with Bent Stem (see page 18)
- Staff Loudspeaker Pod (see page 17)
- Speaker Pod (see page 17)
- PS-55 Power Supply (see page 29)

Optional Extras:

- Counter Hearing Loop Aerial (see page 24)
- Larger base available upon request

Physical Data:

Dimensions (boxed)	Height – 310mm (12.2") Width – 310mm (12.2") Depth – 160mm (6.2")
Construction	ABS Plastic
Finish	Black RAL 9005

Product Codes:

Spkr Pod Screen Mounted Mic System	STS-K072
------------------------------------	----------



Bridge Bar System

This window intercom system features our most popular combined speaker and microphone module in a bridge bar style. It also includes our open duplex amplifier, a hearing loop, and a free-standing staff microphone and speaker unit. It is ideal for a variety of environments, whatever the ambient noise conditions.

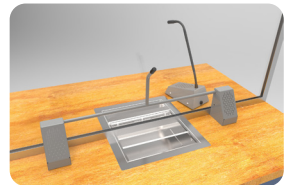

Applications:

For use in any situation where one to one communication is impaired by glass, a security screen, or similar barriers:

- Banks
- Post Offices
- Supermarkets
- Ticket Kiosks
- Information Centres
- Airports

What's Included:

- Window Intercom Amplifier (see page 16)
- Bridge Bar Customer Unit (see page 22)
- Staff Loudspeaker Unit (see page 19)
- PS-55 Power Supply (see page 29)
- Counter Hearing Loop Aerial (see page 24)

Physical Data:

Dimensions (boxed)	Height – 120mm (4.72") Width – 640mm (25.19") Depth – 340mm (13.38")
Weight (boxed)	3.72kg (8.20lbs)
Construction	Mild Steel
	ABS Plastic
Finish	Grey Powder Coated Leatherette
	Black Textured Powder Coated

Product Codes:

Bridge Bar System in Grey	STS-K001L-G
Bridge Bar System in Black	STS-K001L-B



Surface Mounted System

This window intercom system features individual speaker and microphone units for the customer-side. This system also includes our open duplex amplifier, a hearing loop, and a free-standing staff microphone and speaker unit. It is suitable for quiet environments with low ambient noise.

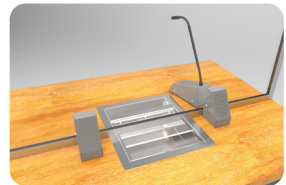

Applications:

For use in quiet environments where one to one communication is impaired by use of glass, a security screen, or similar barriers:

- Banks
- Post Offices
- Information Centres

What's Included:

- Window Intercom Amplifier (see page 16)
- Surface Mounted Speaker and Microphone Modules (see page 20)
- Staff Loudspeaker Unit (see page 19)
- PS-55 Power Supply (see page 29)
- Counter Hearing Loop Aerial (see page 24)

Physical Data:

Dimensions (boxed)	Height – 130mm (5.11") Width – 340mm (13.38") Depth – 240mm (9.44")
Weight (boxed)	2.90kg (6.39lbs)
Construction	Mild Steel
	ABS Plastic
Finish	Grey Powder Coated Leatherette
	Black Textured Powder Coated

Product Codes:

Surface Mounted System in Grey	STS-K002L-G
Surface Mounted System in Black	STS-K002L-B



Flush Mounted System

This window intercom system features speakers that are mounted into the surface for a sleek look. It also includes our flush open duplex amplifier, a hearing loop, and a free-standing staff microphone and speaker unit. It is suitable for quiet environments with low ambient noise, and has been designed to prevent tampering in high-risk environments such as banks and prisons.

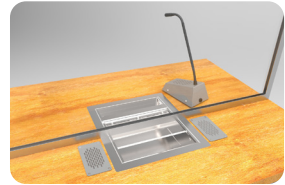

Applications:

For use in quiet environments where one to one communication is impaired by use of glass, a security screen, or similar barriers:

- Banks
- Post Offices
- Information Centres
- Prisons

What's Included:

- Window Intercom Amplifier (see page 16)
- Flush Speakers and Microphone (see page 20)
- Staff Loudspeaker Unit (see page 19)
- PS-55 Power Supply (see page 29)
- Counter Hearing Loop Aerial (see page 24)

Physical Data:

Dimensions (boxed)	Height – 130mm (5.11") Width – 340mm (13.38") Depth – 240mm (9.44")
Weight (boxed)	2.46kg (5.42lbs)
Construction	Mild Steel
	ABS Plastic
Finish	Grey Powder Coated Leatherette
	Black Textured Powder Coated

Product Codes:

Flush Mounted System in Grey	STS-K003L-G
Flush Mounted System in Black	STS-K003L-B



Curved Microphone System

This window intercom system features individual speaker and microphone units for the customer-side. It includes our open duplex amplifier, a hearing loop, and a free-standing staff microphone and speaker unit. It is a low space solution, ideal for a variety of environments with ambient noise.

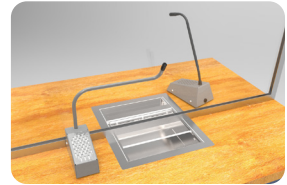

Applications:

For use in quiet environments where one to one communication is impaired by use of glass, a security screen, or similar barriers:

- Banks
- Post Offices
- Supermarkets
- Ticket Kiosks
- Information Centres
- Airports

What's included:

- Window Intercom Amplifier (see page 16)
- Half Bridge Bar Unit (see page 23)
- Staff Loudspeaker Unit (see page 19)
- PS-55 Power Supply (see page 29)
- Counter Hearing Loop Aerial (see page 24)

Physical Data:

Dimensions (boxed)	Height – 160mm (6.29") Width – 310mm (12.20") Depth – 300mm (11.81")
Weight (boxed)	2.62kg (5.77lbs)
Construction	Mild Steel
	ABS Plastic
Finish	Grey Powder Coated Leatherette
	Black Textured Powder Coated

Product Codes:

Curved Left Microphone System in Black	STS-K035-B
Curved Left Microphone System in Grey	STS-K035-G-LH
Curved Right Microphone System in Black	STS-K035-B-RH
Curved Right Microphone System in Grey	STS-K035-G-RH



Slimline Bridge Bar System

This window intercom system features a slimline stainless steel bridge bar unit with a screen-mounted microphone. This system also includes our open duplex amplifier, a hearing loop, and a free-standing staff microphone and speaker unit.

It is a robust option, ideal for a variety of environments with ambient noise.

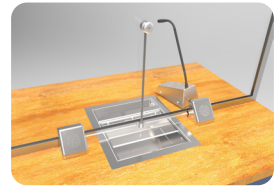

Applications:

For use in any situation where one to one communication is impaired by use of glass, a security screen, or similar barriers:

- Banks
- Post Offices
- Supermarkets
- Ticket Kiosks
- Information Centres
- Airports

What's Included:

- Window Intercom Amplifier (see page 16)
- Slimline Bridge Bar Unit (see page 22)
- Staff Loudspeaker Unit (see page 19) in Brushed Stainless Steel
- PS-55 Power Supply (see page 29)
- Counter Hearing Loop Aerial (see page 24)

Physical Data:

Dimensions (boxed)	Height – 130mm (5.11") Width – 380mm (14.96") Depth – 320mm (12.59")
Weight (boxed)	3.72kg (8.20lbs)
Construction	Stainless Steel
	Mild Steel
	ABS Plastic
Finish	Brushed Stainless Steel
	Black Textured Powder Coat

Product Code:

Slimline Bridge Bar System	STS-K060
----------------------------	----------

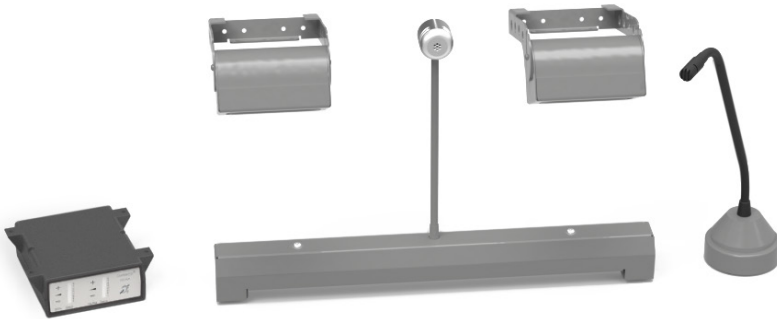

Dual Overhead Speaker System

This window intercom system features our recessed bridge bar with a glass mounted microphone for the customer side, a round based microphone for the staff side and two sealed overhead speaker modules. It also includes our open duplex amplifier and a hearing loop. It is a low-space solution, ideal for a variety of environments with ambient noise.



Applications:

For use in any situation where one to one communication is impaired by use of glass, a security screen, or similar barriers:

- Banks
- Post Offices
- Supermarkets
- Ticket Kiosks
- Information Centres
- Airports

What's Included:

- Window Intercom Amplifier (see page 16)
- Recessed Bridge Bar Unit (see page 17)
- Flexible Gooseneck Microphone (see page 19)
- Overhead Speaker x2 (see page 21)
- PS-55 Power Supply (see page 29)
- Counter Hearing Loop Aerial (see page 24)

Physical Data:

Dimensions (boxed)	Height – 130mm (5.11") Width – 380mm (14.96") Depth – 320mm (12.59")
Weight (boxed)	4.08kg (8.99lbs)
Construction	Mild Steel
	ABS Plastic
Finish	Grey Powder Coated Leatherette
	RAL 9006 Powder Coated Semi Gloss
	Black Textured Powder Coat

Product Code:

Overhead Speaker System	STS-K015-01
-------------------------	-------------



Surface Mounted Entry System

This window intercom system provides high quality sound across partitions or safety screens. It includes our surface mounted call unit, our open duplex amplifier, a hearing loop, and a free-standing microphone and speaker unit for staff.

The surface mounted call unit is designed for installation at head height. The call button on the front of the unit triggers an audible alert to inform staff to a customer’s presence and open a handsfree conversation channel.

This system is suitable for environments with low ambient noise.

Applications:

For use where one to one communication takes place through a safety screen:

- Nursing/Care Homes
- Hospitals/Health Clinics/Surgeries
- Reception Counters
- Banks
- Retail Stores

What’s Included:

- Window Intercom Amplifier (see page 16)
- Surface Mounted Call Unit (see page 12)
- Staff Loudspeaker Unit (see page 12)
- PS-55 Power Supply (see page 29)
- Counter Hearing Loop Aerial (see page 24)

Optional Extras:

- Counter Hearing Loop Aerial (see page 24)
- Larger base available upon request

Physical Data:

Dimensions (boxed)	Height – 310mm (12.2") Width – 310mm (12.2") Depth – 160mm (6.2")
Construction	ABS Plastic
Finish	Black RAL 9005

Product Codes:

Surface Mounted Entry System	STS-K009L-G
------------------------------	-------------



Window Intercom Amplifier

Our amplifier provides full open duplex communication and is compatible with all of our speech transfer products.

Features:

- Energy-saving “green” standby mode is automatically used, achieving a power saving of up to 80%
- Constant-current hearing loop drive (with engineer adjustable hearing loop drive level)
- Isolated audio line input / output allows additional ohmically isolated line level audio input or output to recording system (bespoke, not available together)
- LED column indicator aids adjustments and indicates power and status
- Continuous self-testing means that no specialized equipment is required to confirm functionality
- DC Power: 2.1mm DC jack
- Power and status indication: Green/red LED column

Technical Data:

Supply Voltage	12-14 VDC
Quiescent Current	100mA typical
Operating Current	2A typical on speech peaks
Power Switch	Push on - push off (tact switch under membrane)
Microphones	Electret, supply 5V via 2.2K Ω load resistor
Speaker Output Power	RMS: 2.5W / 8 Ω , 4.4W / 4 Ω
Loop Drive Compliance	Constant current, bounded by 4Vrms & 3Arms
Total Harmonic Distortion	<5% (loop and speakers)

Physical Data:

Dimensions	Height – 116mm (4.57") Width – 115mm (4.53") Depth – 40mm (1.57")
Weight	100g (0.22lbs)
Construction	ABS Plastic Construction Housing
Finish	Matt Black Fine Texture

Product Code:

Window Intercom Amplifier	STS-A31H
---------------------------	----------

Staff Loudspeaker Pod

Our combined speaker and directional microphone pod for the staff side can be either free standing or surface mounted. It provides high quality and uses a cardioid microphone.



Physical Data:

Dimensions	Diameter – 110mm (4.3") Height – 330mm (12.9")
Weight	105g (0.23lbs)
Construction	ABS Plastic
Finish	Black RAL 9005

Product Codes:

Staff Loudspeaker Pod	STS-SU2
-----------------------	---------

Technical Data:

Speaker	RMS	5W
	Impedance	4Ω
	Output	SPL 1W @ 1M 85dB
	Frequency Response	150Hz - 10300Hz
Microphone	Directional Response	Cardioid
	Frequency Response	150Hz - 10500Hz
	Sensitivity	49.5dB+ 2dB @ 1kHz (0dB=1V/pa)
	Impedance	1.6K Ohms+ 3-% @ 1kHz

Speaker Pod

This speaker pod provides high quality sound and can be either free standing or surface mounted.



Physical Data:

Dimensions	Diameter – 110mm (4.3") Height – 30mm (1.18")
Construction	ABS Plastic
Finish	Black RAL 9005

Technical Data:

RMS	5W
Impedance	4Ω
Output	SPL 1W @ 1M 85dB
Frequency Response	150Hz - 10300Hz

Product Code:

Speaker Pod	STS-S70
-------------	---------

Screen Mounted Microphone w/ Bent Stem

A customer-side glass mounted microphone to provide high quality sound.



Physical Data:

Dimensions	Height – 330mm (12.9") Width – 200mm (7.87") Depth – 25mm (0.98")
Weight	105g (0.23lbs)
Construction	Mild Steel
Finish	Black

Technical Data:

Directional Response	Cardioid
Frequency Response	70Hz - 10300Hz
Sensitivity	-47 ±3dB @ 1kHz
Impedance	680 Ohms +/- @ 1KHz

Product Codes:

Screen Mounted Mic w/ Bent Stem	STS-M14-BENT-B
---------------------------------	----------------

Surface Mounted Call Unit

Our customer side speaker and omni-directional microphone set is mounted into a surface for a sleek look.



Technical Data:

Speaker	RMS	5W
	Impedance	4Ω
	Output	SPL 1W @ 1M 85dB
	Frequency Response	150Hz - 10300Hz
Microphone	Directional Response	Omni-Directional
	Frequency Response	100Hz - 5000Hz
	Sensitivity	-42.5 ± 2.0dB @ 1KHz (0dB=1V/pa)
	Impedance	2K Ohms +/- @ 1KHz

Physical Data:

Dimensions	Height – 164mm (6.4") Width – 89mm (3.5") Depth – 63mm (2.48")
Construction	Mild Steel
Finish	Grey Powder Coated Leatherette

Product Codes:

Surface Mounted Call Unit	BACK-BOX
---------------------------	----------

Staff Loudspeaker Unit

Our free-standing combined speaker and directional microphone module for the staff side has an integral loudspeaker, microphone with a semi-rigid stem, adjustable neck and mute switch.

Physical Data:

Dimensions	Height – 370mm (6.30") Width – 95mm (2.76") Depth – 150mm (3.94")
Weight	820g (1.80lbs)
Construction	Mild Steel
	Stainless Steel
Finish	Grey Powder Coated Leatherette
	Black Textured Powder Coated
	Brushed Stainless Steel

Product Codes:

Staff Loudspeaker Unit in Grey	STS-SUI-G
Staff Loudspeaker Unit in Black	STS-SUI-B
Staff Loudspeaker Unit in Stainless Steel	STS-SUI-SS



Technical Data:

Speaker	RMS	5W
	Impedance	4Ω
	Output	SPL 1W @ 1M 85dB
	Frequency Response	150Hz - 10300Hz
Microphone	Directional Response	Cardioid
	Frequency Response	150Hz - 10500Hz
	Sensitivity	49.5dB+ 2dB @ 1kHz (0dB=1V/pa)
	Impedance	1.6K Ohms+ 3-% @ 1kHz

Flexible Gooseneck Microphone

A free-standing directional microphone for the staff side, with a 300mm flexible gooseneck shaft and round base.



Technical Data:

Directional Response	Cardioid
Frequency Response	150Hz - 10500Hz
Sensitivity	49.5dB+ 2dB @ 1kHz (0dB=1V/pa)
Impedance	1.6K Ohms+ 3-% @ 1kHz

Product Code:

Flexible Gooseneck Microphone	STAFFMIC-01-NWB
-------------------------------	-----------------

Physical Data:

Dimensions	Diameter (base) – 70mm (2.75") Height – 340mm (13.38")
Weight	950g (2.09lbs)
Construction	Mild Steel
Finish	RAL 9006 Powder Coated

Surface Mounted Speaker and Microphone

Our customer side, free-standing speaker and omni-directional microphone modules.

Technical Data:

Speaker	RMS	5W
	Impedance	4Ω
	Output	SPL 1W @ 1M 85dB
	Frequency Response	150Hz - 10300Hz
Microphone	Directional Response	Omni-Directional
	Frequency Response	100Hz - 5000Hz
	Sensitivity	-42.5 ± 2.0dB @ 1KHz (0dB=1V/pa)
	Impedance	2K Ohms +/- @ 1KHz

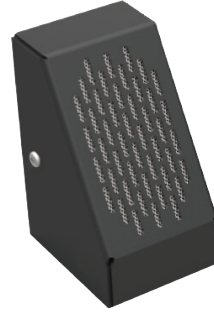

Physical Data:

Dimensions	Height - 75mm (2.95")
	Width - 60mm (2.36")
	Depth - 110mm (4.33")
Weight	550g (1.21lbs)
Construction	Mild Steel
Finish	Grey Powder Coated Leatherette
	Black Textured Powder Coated

Product Codes:

Surface Mounted Speaker in Grey	STS-S60-G
Surface Mounted Speaker in Black	STS-S60-B
Surface Mounted Microphone in Grey	STS-M54-G
Surface Mounted Microphone in Black	STS-M54-B

Flush Speaker and Microphone

Our customer side speaker and omni-directional microphone set is mounted into a surface for a sleek look.

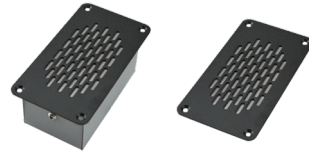

Physical Data:

Dimensions	Height - 50mm (1.97")
	Width - 65mm (2.56")
	Depth - 120mm (4.72")
Weight	450g (0.99lbs)
Construction	Mild Steel
	Zintec Case
Finish	Grey Powder Coated Leatherette
	Black Textured Powder Coated

Technical Data:

Speaker	RMS	5W
	Impedance	4Ω
	Output	SPL 1W @ 1M 85dB
	Frequency Response	150Hz - 10300Hz
Microphone	Directional Response	Omni-Directional
	Frequency Response	100Hz - 5000Hz
	Sensitivity	-42.5 ± 2.0dB @ 1KHz (0dB=1V/pa)
	Impedance	2K Ohms +/- @ 1KHz

Product Codes:

Flush Speaker in Grey	STS-S61-G
Flush Speaker in Black	STS-S61-B
Flush Microphone in Grey	STS-M56-G
Flush Microphone in Black	STS-M56-B

Overhead Speaker

An overhead sealed speaker module designed to be fitted above either the staff or customer side counters.



Physical Data:

Dimensions	Height – 76mm (2.99") Width – 83mm (3.26") Depth – 110mm (4.33")
Weight	562g (1.15lbs)
Construction	Mild Steel
Finish	Powder Coated RAL 9006 Semi Gloss

Technical Data:

RMS	5W
Impedance	4Ω
Output	SPL 1W @ 1m 85dB
Frequency Response	150Hz - 10300Hz

Product Code:

Overhead Speaker	STS-S22-G
------------------	-----------

Surface Mounted Overhead Speaker

An overhead sealed speaker module designed to be fitted above either the staff or customer side counters.



Technical Data:

RMS	5W
Impedance	4Ω
Output	SPL 1W @ 1m 85dB
Frequency Response	150Hz - 10300Hz

Physical Data:

Dimensions	Height – 76mm (2.99") Width – 83.4mm (3.26") Depth – 110mm (4.33")
Weight	562g (1.15lbs)
Construction	Mild Steel
Finish	Powder Coated RAL 9006 Semi Gloss

Product Code:

Surface Mounted Overhead Speaker	STS-S30-G
----------------------------------	-----------

Bridge Bar Customer Unit

Our most popular combined speaker and directional microphone module, designed for the customer side.



Physical Data:

Dimensions	Height – 245mm (9.64") Width – 620mm (24.4") Depth – 75mm (2.95")
Weight	1.44kg (3.17lbs)
Construction	Mild Steel
Finish	Grey Powder Coated Leatherette
	Black Textured Powder Coated

Technical Data:

Speaker	RMS	5W
	Impedance	4Ω
	Output	SPL 1W @ 1M 85dB
	Frequency Response	150Hz - 11000Hz
Microphone	Directional Response	Cardioid
	Frequency Response	70Hz - 14000Hz
	Sensitivity	-67dB +/- 3dB @ 1kHz
	Impedance	1.6K Ohms +/- 30% @ 1KHz

Product Codes:

Bridge Bar Customer Unit in Grey	STS-B80-G
Bridge Bar Customer Unit in Black	STS-B80-B

Slimline Bridge Bar Unit

Our customer side slimline stainless steel bridge bar unit with a combined speaker and screen mounted directional microphone.



Technical Data:

Speaker	RMS	5W
	Impedance	4Ω
	Output	SPL 1W @ 1M 85dB
	Frequency Response	150Hz - 11000Hz
Microphone	Directional Response	Cardioid
	Frequency Response	70Hz - 10300Hz
	Sensitivity	-47 ±3dB @ 1kHz
	Impedance	680 Ohms +/- @ 1KHz

Physical Data:

Dimensions	Width – 581mm (22.8") Height – 431mm (16.9") Depth – 60mm (2.36")
Weight	1.44kg (3.17lbs)
Construction	Mild Steel
Finish	Brushed Stainless Steel

Product Code:

Slimline Bridge Bar Unit	STS-B90-SS
--------------------------	------------

Recessed Bridge Bar Unit

Our customer side recessed bridge bar unit with a screen mounted directional microphone.

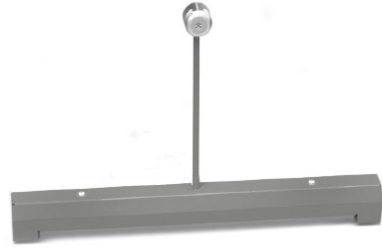

Technical Data:

Directional Response	Cardioid
Frequency Response	70Hz - 10300Hz
Sensitivity	-47 ±3dB @ 1kHz
Impedance	680 Ohms +/- @ 1KHz

Physical Data:

Dimensions	Height – 330mm (1.69") Width – 400mm (15.7") Depth – 34mm (1.34")
Weight	516g (1.10lbs)
Construction	Mild Steel
Finish	RAL 9006 Powder Coated

Product Code:

Recessed Bridge Bar Unit	STS-B100-G
--------------------------	------------

Half Bridge Bar Unit

Our combined speaker and directional microphone for counters with reduced space.



Technical Data:

Speaker	RMS	5W
	Impedance	4Ω
	Output	SPL 1W @ 1M 85dB
	Frequency Response	150Hz - 11000Hz
Microphone	Directional Response	Cardioid
	Frequency Response	70Hz - 14000Hz
	Sensitivity	-67dB +/- 3dB @ 1kHz
	Impedance	1.6K Ohms +/- 30% @ 1KHz

Physical Data:

Dimensions	Height – 240mm (9.44") Width – 280mm (11.02") Depth – 130mm (5.11")
Weight	757g (1.67lbs)
Construction	Mild Steel
Finish	Grey Powder Coated Leatherette
	Black Textured Powder Coated

Product Codes:

Curved Left Half Bridge Bar Unit in Black	STS-B94-LH-B
Curved Left Half Bridge Bar Unit in Grey	STS-B94-LH-G
Curved Right Half Bridge Bar Unit in Black	STS-B94-RH-B
Curved Right Half Bridge Bar Unit in Grey	STS-B94-RH-G



Counter Hearing Loop Aerial

This hearing loop aerial for use with our Window Intercom Systems (see pages 6-15), which is fixed under desks or counters.

When connected to our Window Intercom Systems, it transmits a magnetic field which enables the telecoil in the hearing instrument to receive a signal from our hearing loop driver.

It is positioned within 1.2m of a user’s hearing instrument and fixed in place using self adhesive clips, P-clips or hot glue. It is flexible and can be moulded into your desired shape.

Physical Data:

Dimensions	Can be moulded on site to required size/shape by installers
Weight	100g (0.22lbs)
Construction	Copper Wire with Black Protective Covering
Finish	Black PVC

Product Code:

Counter Hearing Loop Aerial	IL-AE99
-----------------------------	---------



Break Out Box

Our Break Out Box is used in addition or as a replacement to the staff unit. The box silences loudspeaker noise and allows staff to hear clearly through headsets. This product is a must have for busy ticket booths or service-points where ambient noise conditions are high.

A version with a mute button and an RJ11 socket is available for connection to the SC 230 and SC 260 Easy Disconnect Plug (see page 26).

Features:

- Push button mute switch
- Headset and handset connection
- Compact
- Easy to install
- Version with RJ11 connection available

Technical Data:

Connections	Break Out Box (RJ11 Connection)	
	Headset Loudspeaker(s) and Microphone – B.O.B. Headphones and Microphone	RJ11 Connection
	Break Out Box (3.5mm Connection)	
	Headset Microphone – B.O.B. Microphone	3.5mm TRS Connection
	Headset Loudspeaker(s) – B.O.B. Headphones	3.5mm TRS Connection
	Break Out Box (3.5mm Jack & RJ11 Connection)	
	B.O.B. Microphone (Grey Sleeve) – STS-A31	2 pin Euro-block Connector
	B.O.B. loudspeaker (Black Sleeve) – STS-A31	2 pin Euro-block Connector
	Staff Loudspeaker Unit – B.O.B. MIC	2 pin Euro-block Connector
	Staff Loudspeaker Unit – B.O.B. SPKR	2 pin Euro-block Connector

Applications:

For use in combination with a speech transfer system, in any situation where one to one communication takes place at a counter, booth or desk, such as in:

- Banks
- Post Offices
- Ticket Kiosks
- Information Centres
- Airports

Physical Data:

Dimensions	Height – 20mm (0.79") Width – 117.6mm (4.63") Depth – 39mm (1.54")
Weight	100g (0.22lbs)
Construction	ABS Plastic
Finish	Black

Product Code:

Break Out Box (3.5mm)	STS-SJB
Break Out Box (RJ11 Connection)	STS-SJB-RJ

SC 230 Headset & Microphone

The SC 230 is a single-ear headset which allows staff to converse clearly with customers while maintaining communication with the staff-side of counters. It has a built-in noise cancelling boom microphone.

The headset is used in conjunction with our Break Out Box (see page 25). It features a flexible microphone, a comfortable adjustable headband, and clear audio reproduction.

Features:

- Durable Easy Disconnect plug (RJ11 connection)

Physical Data:

Dimensions (boxed)	Height – 153mm (6.02") Width – 200mm (7.87") Depth – 59mm (2.32") Connection Cable Length – 1m (39.37")
Weight	58g (0.12lbs)
Construction	ABS Plastic
Finish	Black



Technical Data:

Impedance	~200Ω
Frequency Response	Headphones: 150 - 6,800Hz
	Microphone: 50 - 18,000Hz
Microphone Type	Noise-Cancelling
Sound Pressure Level	103dB limited by ActiveGard®

Product Code:

SC 230 Headset & Microphone	HEADSET-1EAR-RJ
-----------------------------	-----------------

SC 260 Headset & Microphone

The SC 260 is a double-sided headset. It has a built-in noise cancelling boom microphone.

The headset is used in conjunction with our Break Out Box (see page 25) as part of our Window Intercom Systems. It features a flexible microphone, a comfortable adjustable headband, and clear audio reproduction.

Features:

- Durable Easy Disconnect plug (RJ11 connection)

Physical Data:

Dimensions (boxed)	Height – 153mm (6.02") Width – 200mm (7.87") Depth – 59mm (2.32") Connection Cable Length – 1m (39.37")
Weight	86g (0.18lbs)
Construction	ABS Plastic
Finish	Black



Technical Data:

Impedance	~200Ω
Frequency Response	Headphones: 150 - 6,800Hz
	Microphone: 50 - 18,000Hz
Microphone Type	Noise-Cancelling
Sound Pressure Level	103dB limited by ActiveGard®

Product Code:

SC 260 Headset & Microphone	HEADSET-2EAR-RJ
-----------------------------	-----------------

PC 2 Headset & Microphone

The PC 2 is a single-ear stereo headset with a built-in noise-cancelling microphone, a 2 metre cable, and 3.5mm colour-coded jacks.

The headset is used in conjunction with our Break Out Box (see page 25). It features a flexible microphone, a comfortable adjustable headband, and clear audio reproduction.

Its single-ear speaker allows staff to converse clearly with customers while maintaining communication with the staff-side of counters.



Physical Data:

Dimensions (boxed)	Height – 244mm (9.60") Width – 212mm (8.34") Depth – 64.5mm (2.53") Connection Cable Length – 2m (78.74")
Weight	55g (0.12lbs)
Construction	ABS Plastic
Finish	Black

Technical Data:

Sound Pressure Level	Headphones: 95dB
Sensitivity	Microphone: -40dBV
Frequency Response	Headphones: 42 - 17,000Hz
	Microphone: 90 - 15000Hz
Impedance	Headphones: 32Ω
	Microphone: 2k
Pick-Up Pattern	Uni-Directional

Product Code:

PC 2 Headset & Microphone	HEADSET-1EAR
---------------------------	--------------

PC 3 Headset & Microphone

The PC 3 is a stereo headset with a built-in noise cancelling boom microphone, a 2 metre cable, and 3.5mm colour-coded jacks.

The headset is used in conjunction with our Break Out Box (see page 25). It features a flexible microphone, a comfortable adjustable headband, and clear audio reproduction.



Physical Data:

Dimensions (boxed)	Height – 244mm (9.60") Width – 212mm (8.34") Depth – 64.5mm (2.53") Connection Cable Length – 2m (78.74")
Weight	77g (0.16lbs)
Construction	ABS Plastic
Finish	Black / Silver

Technical Data:

Sound Pressure Level	Headphones: 95dB
Sensitivity	Microphone: -40dBV
Frequency Response	Headphones: 42 - 17,000Hz
	Microphone: 90 - 15000Hz
Impedance	Headphones: 32Ω
	Microphone: 2k
Pick-Up Pattern	Uni-Directional

Product Code:

PC 3 Headset & Microphone	HEADSET-2EAR
---------------------------	--------------



Mouse Microphone

Our discreet Mouse Microphone is for installations with limited counter space, designed to attach to tills or computer screens using double sided tape.

Physical Data:

Dimensions	Height – 12mm (0.49") Width – 24mm (0.97") Length – 25mm (1") Connection Cable Length – 2m
Weight	26g (0.57lbs)
Construction	ABS Plastic
Finish	Black Fine Texture

Technical Data:

Directional Response	Omni-Directional
Frequency Response	70Hz - 20kHz
Sensitivity	-46dBv @ 1kHz
Distortion	Typically less than 1%

Product Code:

Mouse Microphone	STS-M70
------------------	---------



PS-55 Power Supply

The PS-55 Power Supply is a Level VI power supply for use with:

- Window Intercom Amplifier (see page 16)

Complies with UL, RCM, KC, FCC, CE (EMC), and CCC standards.

All power supplies come with a region-specific IEC lead 2 metres in length as standard.

Physical Data:

	PS-55 Power Supply	IEC Lead
Dimensions	Height – 93mm (3.66") Width – 49mm (1.93") Depth – 36mm (1.42") Cable Length – 1.8m (70.87")	Cable Length – 2m (78.7")
Weight	180g (0.39lbs)	90g (0.2lbs)
Construction	ABS Plastic	PVC
Finish	Black	Black

Technical Data:

Input	100-240V – 50-60Hz
Output	14V 2.14A 30W max.

Product Code:

PS-55 Power Supply w/ IEC UK	PS-55-01-UK
PS-55 Power Supply w/ IEC Europe	PS-55-01-EU
PS-55 Power Supply w/ IEC Switzerland	PS-55-01-CH
PS-55 Power Supply w/ IEC US & Japan	PS-55-01-USJ
PS-55 Power Supply w/ IEC Australia	PS-55-01-AUS



Contact us now on:

☎ +44 (0) 1732 223900

✉ sales@contacta.co.uk

📠 +44 (0) 1732 223909

Contacta Systems Ltd
Office 13, Dana Estate
Transfesa Road
Paddock Wood, Kent
TN12 6UT
United Kingdom

www.contacta.co.uk

tele  **cron**

telecroatian network
www.telecron.hr